

1 2 3 4 5 6 7 8

REV	DESCRIPTION	DRW	DATE
A	NEW	LI LI	2010-5-16

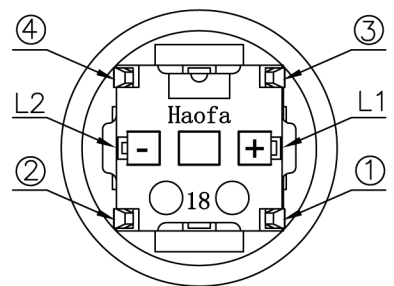

CIRCUIT

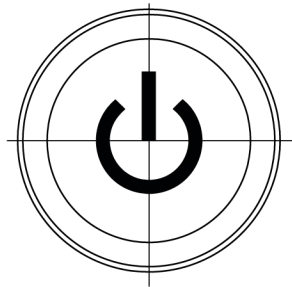
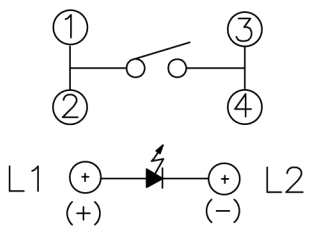

- NOTES:
- 1.RATING: 12VDC 50mA
 - 2.CONTACT RESISTANCE: 100mΩ Max
 - 3.INSULATION RESISTANCE: 100MΩ 250VDC FOR 1MIN
 - 4.DIELECTRIC STRENGTH: 250VAC(50/60Hz) FOR1MIN
 - 5.LIFE TEST:100,000 CYCLES
 - 6.OPERATION FORCE&TRAVEL: SEE SPECIFICATION

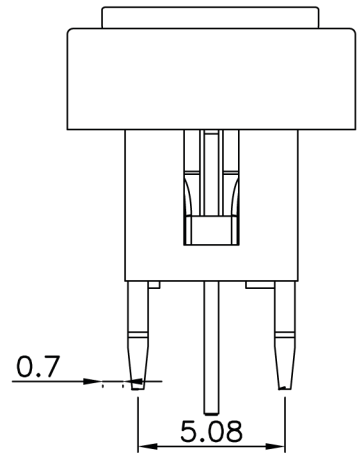
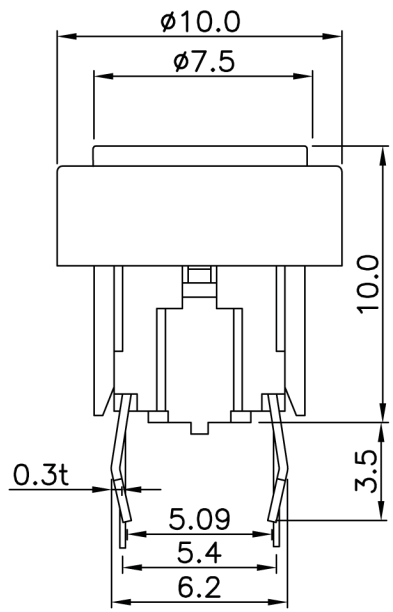
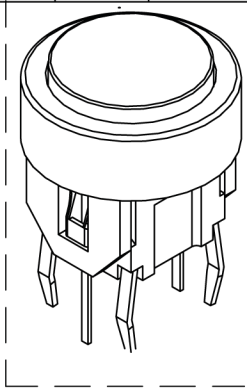

P.C.B LAYOUT

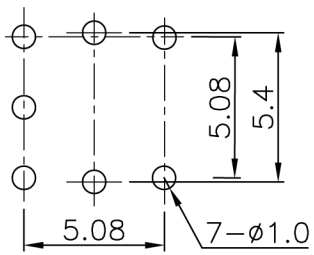

6		
5	TERMINAL	Bronze Silver Plated
4	CONTACT	ABS
3	LED	GaAsP/GaP
2	BUTTON	POM
1	HOUSING	PBT
	ITEM	PART NAME MATERIAL

乐清市戴尔电子有限公司
YUEQING DAIER ELECTRON CO., LTD

LED COLOR									
1	2	3	4	5	6	12	13	14	23
Red	Yellow	Green	Blue	White	Pure Green	Red Yellow	Red Green	Red Blue	Yellow Green

TOLERANCE				PART NO.:		TITLE	
UNLESS OTHERWISE STATED				带灯开关		TACT SWITCH	
X.X	±0.25	∠	±0.5'	DRAWN	DATE	MODEL	
X.XX	±0.1	UNIT	mm	LI LI	2010.05.16	TSL-A061-2DL1	
REV	A	SCALE	4:1	CHK'D	DATE	MATL	
SIZE	A4	SHEET	1 OF 1	Wang	2010.05.16	FINISH	

1 2 3 4 5 6 7 8